

2012

4th World Implant Orthodontics Conference 2012

10-13 October 2012 | Hilton Hotel | Sydney

Registration Brochure & Call For Abstracts

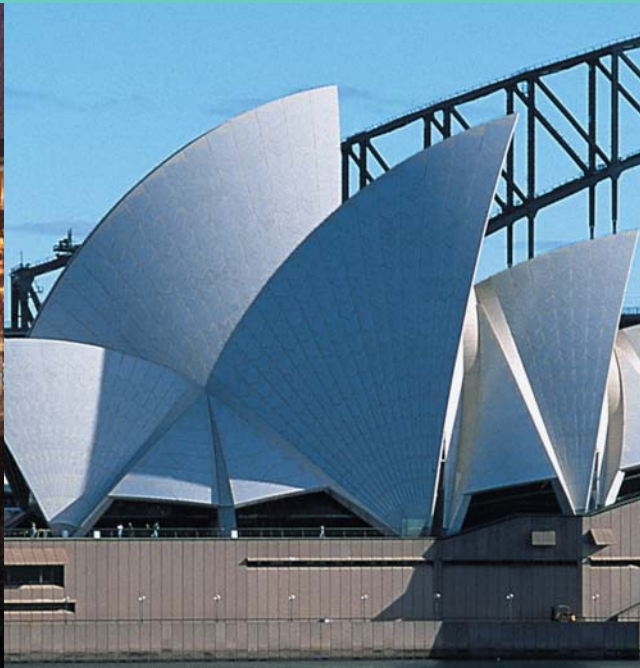

W



4th World Implant Orthodontic Conference

www.wioc2012.com ABN: 47 067 147 411

Sponsors



Contents

President's Invitation	3
Committees	3
Invited Speakers	4
Sponsorship & Exhibition	9
Program at a Glance	10
Call for Abstracts	12
Registration Information	13
Social Program	15
Host City & Venue	15
General Information	16
Accommodation	18
Day Tours	19
Contact Us	Back cover

Conference Organisers



WIOC2012 Conference Secretariat

GPO Box 3270

Sydney NSW 2001

AUSTRALIA

Tel: +61(0) 2 9254 5000

Fax: +61 (0) 2 9251 3552

Email: info@wioc2012.com

Key Dates

Call for Abstracts Opens	January 2012
Closing Date for Abstracts	12 May 2012
Notification of Acceptance of Abstract	12 June 2012
End of Early Bird Registration	31 July 2012
Accommodation Booking/ Cancellation Deadline	1 September 2012
WIOC2012	10-13 October 2012

Invitation

It is my great honour and pleasure to invite you to the 4th World Implant Orthodontic Conference (WIOC) in Sydney on 10 – 13 October, 2012.

We are very excited to see you in the vibrant city of Sydney in Australia as this is the first WIOC held in the Southern Hemisphere. The theme of this WIOC is “Paradigm Shift with TADs...Too good to be true ?”

The program for 2012 will be both Scientific, with the most updated research, and Clinical, the tips and tricks in clinical usage of Temporary Anchorage Devices (TADs). The program also introduces the opportunity for postgraduate students to present their research in the field of implant orthodontics and for the first time, a prize will be awarded for the best research presentation.

The conference social program will provide a unique Australian experience to both you and your guest. This would also be a great opportunity to catch up with friends and colleagues and at the same time enjoy the fine Australian wines and foods.

I look forward in seeing you all at the 4th WIOC in Sydney!

Prof. M. Ali Darendeliler
WIOC2012 President

Committees

Organising Committee

President: Prof M. Ali Darendeliler

Co-President: Dr Michael Dineen

Secretary: Dr Lam Cheng

Dr Tissa Jayasekera

Dr Oyku Dalci

Dr Vasanth Srinivasan

Scientific Committee

Chair: Prof M. Ali Darendeliler

Co-Chair: Dr Carmen Gonzales and Dr Oyku Dalci

International Advisory Committee

Associate Professor Ricky Wong

Professor Jungi Sugawara

Professor Eric Liou

Professor Young Chel Park

Professor Tamer Turk

Professor Birte Melsen

Professor Glen Sameshima

Professor Om P Kharbanda

Dr Somchai Satravaha

Professor Hugo De Clerck

Dr Camillo Morea

Professor W. Eugene Roberts

Professor Ravi Nanda

Associate Professor Benedict Wilmes

Professor Baohua Xu

Dr Carlo Lorenzo

Professor Abbas Zaher

Professor Julia Harfin

Professor Manuel Adriaola

Dr Gisella Contasti

Professor Noriaki Yoshida

Speakers

George Anka



He received his training of Oral Surgery Science at The Tokyo Women Medical College, Tokyo, Japan in 1973, The Tohoku University in 1974 and The Aichigakuin University, Nagoya from 1975 to 1978.

Ortho-gnathic Surgery is one of his specialties; he entered Northwestern University, Chicago, USA from 1979-1981 for his Orthodontic training, where he received Master of Science Degree 1981 at the same institution.

He began his teaching carrier at Nihon University Pedodontic Department, Tokyo from 1984 to 2004, after which he taught as a part time faculty at the post graduate students Orthodontic Department from 2004 up to present.

In the last 15 years he has lectured in Japan and all over the World in major meetings, has written and published scientific articles in National and International Journals as well as several chapters of the International Text Book.

He is maintaining a private practice in Tamashi, Tokyo, Japan. At present he is a Member of Implant Orthodontic Conference Committee of Japan and Advisor Committee of World Implant Orthodontic Conference

Sebastian Baumgaertel

Sponsored by 



Dr. Baumgaertel is a Clinical Associate Professor & Director of Skeletal Anchorage Clinic at Case Western Reserve University in Cleveland, OH, where he also maintains an active private practice. He is a Diplomat of The American Board of Orthodontists, A Fellow of

the Royal College of Dentists of Canada and a certified specialist in Germany.

Dr. Baumgaertel is the author of multiple articles in peer-reviewed journals, Co-editor of the textbook "Mini-implants in Orthodontics: Innovative Anchorage Concepts", AJO-DO Editorial Review Board, International lecturer on TAD's and CBCT technology and has presented 100+ Lectures & Seminars on TAD's

Jung-Yul Cha



Dr. Jung Yul Cha, a graduate of the University of Yonsei, Seoul, Korea received his dental and orthodontic education at Yonsei University. He obtained a degree of doctor at the same university. Now he is a full-time faculty member of Dental College of Yonsei University and a

scientific board member of Korean Journal of Orthodontics. He also worked at orthodontic department, University of Southern California as a visiting scholar 2004. His research topic is about the stability of mini-implant and digital dentistry using virtual model. He was a speaker at pre-Conference of AAO meeting, 2010, and published many scientific articles related to mini-implants to international journals.

ChooRyung Chung



Professor Chung received a DDS in Yonsei University, Korea and a Ph.D. from Orthodontic Science, Tokyo Medical and Dental University, Japan. Dr. Chung is currently assistant professor at the department of Orthodontics, College of Dentistry, Yonsei University, Seoul, Korea.

Professor Chung has interests in clinical managements of complex cases combined with temporomandibular disorders and adult orthodontics. Her research topics include stem cell biology and tissue regeneration therapy.

M. Ali Darendeliler



Dr Darendeliler is Professor and Chair of Orthodontic, Discipline of Orthodontics, at the University of Sydney and Head of Department, Sydney Dental Hospital, Sydney South West Area Health Service. He received his dentistry training from the University of Istanbul and his

PhD from the University of Gazi, in Turkey and his first specialist training in orthodontics from the University of Geneva, Switzerland and his second specialist training from the High Education Council, Turkey. During the course of his career he has undertaken duties as a clinical instructor, research and postgraduate coordinator (Maître d'Assisstant et de Recherche) at the University of Geneva, Assistant Professor at the University of North Carolina, Research Professor at the University of Southern California. His research interests include orthodontic tooth movement, root resorption, obstructive sleep apnoea, temporary anchorage devices, sequential aligners, self-ligating brackets, orthopaedic treatment modalities, magnetic fields and forces and dentofacial orthopedics. He lectured in North and South America, Europe, Asia, Africa and Australia

Dieter Drescher



Prof. Drescher studied dentistry from 1977 to 1982 at the University of Bonn. He received his doctor degree from the University of Bonn in 1984. From 1984 to 1988 he attended the postgraduate course in orthodontics at the University of Bonn and became a certified

orthodontist in 1988. In 1991 he received his Ph.D. From 1993 to 1997 he served as professor and head of the Department of Orthodontics until he received a call to the University of Düsseldorf. Since 1997 he has been working as professor and head of the Department of Orthodontics at the University of Düsseldorf. Since 2002 he has served as Executive Director of the Center of Dentistry at the University of Düsseldorf. Prof. Drescher published extensively on orthodontic materials and skeletal anchorage. He received several academic awards.

Jorge Faber



Dr. Faber is Professor of Orthodontics and Evidence Based Dentistry of the University of Brasilia. He holds a Master degree in Orthodontics and PhD degree in Biology-Morphology. He received the 2010 Best Case Report of the Year Award, for the Best Case Report published in 2009 in AJODO. He served as editor of Dental Press Journal of Orthodontics for five years, and now is the Editor-in-Chief of the Journal of the World Federation of Orthodontists.

Peter Goellner



Dr Peter Göllner did a postgraduate degree in orthodontics and dentofacial orthopaedics at the University of Bern, Switzerland. Since 1997 he has treated 524 patients with palatal implants, 224 patients with miniscrews and 67 patients with miniplates.

Seung Hak-Baek



Dr Baek is Chair and Professor, Dept. of Orthodontics, School of Dentistry, Seoul National University, Director of Planning and Coordination, Seoul National University Dental Hospital, Secretary-General in Korean Association of Orthodontists, and Vice-President in Korean Cleft Lip and Palate Association. In addition, he is a member of Editorial Review Board, Angle Orthod. He received a 2009 CDABO Case Report of the year about transport distraction osteogenesis in Boston AAO meeting.

Sarandeep Huja



Dr. Sarandeep Huja is the Division Chief of Orthodontics at the University of Kentucky. Dr. Huja initially received his dental and orthodontic training from India. From 1993-2001, he was associated with three US institutions, receiving his MS (1995) from Marquette University, Milwaukee, his PhD (1999) and Orthodontic Certificate (1999) from Indiana University, Indianapolis and his DDS (2001) from University of Nebraska Medical Centre College of Dentistry, Lincoln. He has been and currently is PI/Co-I on grants from the NIDCR, NIA, American Academy of Implant Dentistry, Delta Dental and the American Association of Orthodontist Foundation. His research seeks to understand bone remodelling and adaptation to physical forces. His clinical interests include skeletal anchorage, biomechanics of tooth movement and an interdisciplinary focus to treating patients with compromised malocclusions. He is an Orthodontic consultant to the Commission on Dental Accreditation. He is currently on the Editorial Review Board of the Angle Orthodontist, American

Journal of Orthodontics, Journal of Dental Biomechanics. Dr. Huja is a member of the Angle Society and a Diplomat of the American Board of Orthodontics. Dr. Huja maintains an intramural faculty practice.

Yasuhiro Itsuki



Dr. Itsuki graduated from Faculty of Dentistry, Tohoku University, Japan (D.D.S.) and received degree of PhD from Graduate School of Dentistry, Tsurumi University, Japan. Currently he maintains a private clinic, Jingumae Orthodontics, in Tokyo, Japan.

He is Diplomat of Japanese Orthodontic Board and member of Japanese Orthodontic Society, Japanese Society of Oral Implantology, Japanese Cleft Palate Association, Japanese Society of Jaw deformities, European Orthodontic Society, American Association of Orthodontists and WFO.

Om Kharbanda



Dr. Om P Kharbanda is Professor and Head, Division of Orthodontics and Dentofacial Orthopaedics at the All India Institute of Medical Sciences, New Delhi. Dr. Kharbanda earned his BDS (1976) with honours from King George's Medical College Lucknow followed by MDS Orthodontics (1978). Later he completed his MOrthRCS (Edinburgh) and Masters in Medical Education (M MED) from the University of Dundee. Dr. Kharbanda has been a postgraduate teacher since 1986 and has supervised more than 60 theses at AIIMS and at University of Sydney where he served from 2000-2003. His book entitled 'Orthodontics: Diagnosis and Management of Malocclusion and Dentofacial Deformities': Elsevier 2009, has become popular in a short time. Dr. Kharbanda has authored/co-authored more than 110 papers/case reports/ book chapters in peer reviewed international and national journals. Dr. Kharbanda is a former Chief Editor of Journal of Indian Orthodontic Society and is on board of a number of international orthodontic journals. Dr. Kharbanda is Past President of Indian Orthodontic Society and Indian Cleft lip Palate and Craniofacial Association. Currently he is Co-chair 8th Asian Pacific Orthodontic Conference 2012. Since 2004 his team is aggressively involved in clinical and fundamental research on host and implant related factors contributing to the success of orthodontic miniscrew implants.

Speakers

Sunny Seong-Hun Kim



Seong-Hun Kim, DMD, MSD, PhD is an Associate Professor of the Department of Orthodontics School of Dentistry, Kyung Hee University. He is also a visiting assistant professor of the Division of Orthodontics, Department of Orofacial Sciences at University of California, San Francisco (UCSF). Dr. Kim obtained an Orthodontic certificate and MS in Department of Orthodontics, School of Dentistry at the Kyung Hee University, Seoul, Korea, and PhD in Department of Orthodontics, School of Dentistry at the Seoul National University, Seoul, Korea. He is currently the Editor of Clinical Affairs in the Korean Journal of Orthodontics (SCIE journal) in Seoul, Korea and also the editorial reviewer board in the American Journal of Orthodontics and Dentofacial Orthopedics, The Angle Orthodontist, Orthodontics and Craniofacial Research, Saudi Medical Journal, International Journal of Oral and Maxillofacial Implants (SCI journal), and Journal of World Federation of Orthodontists (JWFO). He is a member of World Federation of Orthodontists (WFO) and Korean Society of Speedy Orthodontics (KSSO). Dr. Kim lectures and presents seminars in the United States and internationally about this topic. He also teaches and lectures at UCSF School of Dentistry about implant orthodontics, and he is the author of five international text books and over 120 international and domestic scientific articles about this topic.

Tae-Woo Kim



Tae-Woo KIM is Professor in Orthodontics, Seoul National University, where he completed his orthodontic specialty training in 1986. He was a visiting professor (1995-7) of University of Washington. He was an editor-in-chief of Korean Journal of Orthodontics (KJO). He is Vice president of Korean Association of Orthodontics. He works as a reviewer of KJO, AJODO and other famous international journals. His focused research fields are TMD, mini-implants and long-term stability.

A.M. Kuijpers-Jagtman



Anne Marie Kuijpers-Jagtman has been Professor and Chairperson of the Department of Orthodontics and Craniofacial Biology at the Radboud University Nijmegen, The Netherlands, since 1995. Professor Kuijpers-Jagtman is Councillor of the World Federation of Orthodontists (WFO).

In 2002 she was honoured with the Fellowship in Dental Surgery by Election of the Royal College of Surgeons of England, in 2004 she received the Cesare Luzzi Memorial Award of SIDO in Italy, and in 2011 the Swiss Paul Herren Award. She was awarded Knight in the Order of Orange-Nassau (Royal Honour of Her Majesty the Queen) for services to cleft lip and palate in 2007. In

2009 and 2011 her group received the Samuel Berkowitz Award of the American Cleft Palate Craniofacial Association for the best publication on long-term results of cleft lip and palate treatment. Professor Kuijpers-Jagtman is Editor-in-Chief of Orthodontics and Craniofacial Research. She has undertaken extensive research during the last 25 years in the areas of cleft lip and palate and the biological background of orthodontics. In recent years, her major interests have been in 3D-imaging in orthodontics and evidence based orthodontic therapy. She (co)authored over 260 publications in Medline on her main topics of interest.

Shingo Kuroda



Dr. Shingo Kuroda is the Associate Professor of Department of Orthodontics and Dentofacial Orthopedics at the University of Tokushima Graduate School. He is a Diplomate of the Japanese Orthodontic Board and a member of the International review board for American Journal of Orthodontics and Dentofacial Orthopedics. After a postgraduate course at Osaka University, he was an Assistant Professor in Okayama University for 8 years. Since 2009, he has worked at Université de Montréal for 2 years, as a visiting researcher under Professor Antonio Nanci in Laboratory for the Study of Calcified Tissues and Biomaterials and a clinical instructor in Section of Orthodontics.

Hee-Moon Kyung



Dr. Hee-Moon Kyung is Professor and Chair of the Department of Orthodontics at Kyungpook National University in Daegu, Korea. Dr. Kyung is one of the most experienced clinicians in the development and utilization of microimplants in orthodontic treatment worldwide. He has given more than 200 courses throughout world about microimplant anchorage and lingual orthodontic treatment. He is a principle author of the book entitled Microimplants in Orthodontics, a volume that describes in detail the protocols used by Dr. Kyung and his colleagues. He is an active member of Angle Society.

Seung-Hyun Kyung



Dr Laursen received his dental degree from Aarhus University in 2001 and became a certified orthodontist in 2007. Dr Laursen works part time as a clinical Assistant Professor at the Department of Orthodontics, Aarhus University and part time in private and public orthodontic offices.

At the Department of Orthodontics, Aarhus University Dr Laursen is involved in the treatment of patients with special needs and he teaches post-graduate students. His research is concentrated on the dento-alveolar bone complex in relation to orthodontic tooth movement and insertion of mini-implants.

Kee-Joon Lee



Dr. Kee-Joon Lee received DDS and PhD degree from Graduate school, College of Dentistry, Yonsei University, Seoul, Korea. He is currently an associate professor at Department of Orthodontics, Yonsei University, also an adjunct professor at Temple University, Philadelphia, PA.

He contributed book chapters on biomechanics of miniscrew-driven orthodontics and related non-extraction treatment in adults. He has published many articles and case reports regarding miniscrew implants in orthodontic journals including two cover issues in AJO-DO. His fields in research include clinical biomechanics regarding TADs application and the suture biology in normal growth and in FGFR2-related congenital deformity.

Jang Yeol Lee



Dr. Lee is currently co-director of the Smileagain orthodontic center in Seoul, Korea. He is Clinical Professor in Department of Orthodontics, Yonsei University, Seoul, Korea and also Clinical Professor in Department of Orthodontics, Samsung Medical Center,

Sungkunkwan University, Seoul, Korea and Associate Fellow in the Department of Orthodontics, University of Warwick, UK. He received his dental and orthodontic education at Yonsei University, Seoul, Korea and completed his master and Ph. D degrees in the same school. Dr. Lee is also a visiting scholar in the department of orthodontics, school of dentistry at the University of North Carolina, USA.

Dr Lee was the Secretary General of the 4th Asian Implant Orthodontic Conference in Seoul, 2005 and he was also the Secretary General of the organizing committee in the 1st World Implant Orthodontic Conference held in 2008. Currently he holds a position of Secretary General of World Implant Orthodontic Association.

James Cheng-Yi Lin



Dr. Lin is a Clinical Assistant Professor at the School of Dentistry at the National Defense Medical University of Taipei, Taiwan. He is a member of the editorial review boards of Journal of Taiwan Association of Orthodontists, Journal of Clinical Orthodontics, International

Journal of Medicine Medical Sciences and International Journal of Case Reports and Images. He is a Diplomate of the Taiwan Association of Orthodontists, Taiwan Academy of Aesthetic Dentistry, Taiwan Formosa Academy of Implant Dentistry, and Japanese Society of aesthetic Dentistry, a fellow of the American Association of Orthodontists, World Federation of Orthodontists, International Conference of Oral Implantologists and other professional organisations. He is the current Secretary General of Taiwan Academy of Aesthetic Dentistry. Dr. Lin has been involved with postgraduate teaching at the

Chang Gung University, Taipei Medical University and National Defense Medical University. His main fields of interest focus in TADs-anchored orthodontics and overall aesthetics-driven interdisciplinary treatment. He has developed and patented orthodontic miniscrew products which greatly increase the success for orthodontic anchorage. He has authored or co-authored several articles and book chapters related to TADs-anchored orthodontics as well as aesthetic interdisciplinary treatment dentistry.

Dr. Lin lectures both nationally and internationally, and holds a private practice centered on orthodontics, implant dentistry and overall aesthetics-driven interdisciplinary treatment for adult patients in Taipei, Taiwan.

Eric Liou



Dr. Eric Liou is an association professor and the deputy chairman in the Faculty of Dentistry, Chang Gung Memorial Hospital & Chang Gung University, Taipei, Taiwan. He is also a visiting professor in the Department of Orthodontics, Showa University, Tokyo, Japan. For the

professional affiliations, Dr. Liou is currently the deputy president of Taiwan association of Orthodontists, and president elect of the World Implant Orthodontic Association. His main research interests are distraction osteogenesis, TADs, orthodontic tooth movement, platelet rich plasma, and bone physiology. Dr. Liou has numerous publications and presentations, specially on the topics of accelerated orthodontic tooth movement, maxillary orthopedic protraction, surgery first accelerated orthognathic surgery, and TADs.

Bjorn Ludwig



Dr Bjorn Ludwig has his own private orthodontic practice in Traben-Trarbach, Germany. He is scientific coordinator and Assistant Professor of the University of Homburg/Saar, Department of Orthodontics.

He teaches in the program of further education for orthodontics in the Association of Dentists and the University of Frankfurt/Main (Erasmus). His focus of research work is cortical anchorage with mini-screws and their further clinical development. He has published more than 80 scientific papers about miniscrews, cleft palate and interdisciplinary cases. Dr Ludwig gives lectures and hands-on courses about mini-screws and lingual treatment worldwide. He has contributed chapters in books and is also editor of the book "Mini-implants in orthodontics", Quintessenz, Berlin, London and the book "Selfligating brackets-treatment and concepts" Thieme, Stuttgart, New York.

As well as doing reviews for some major journals, he is contributing editor of the journal of clinical orthodontics, IOK and scientific editor of German orthodontic tribune.

Speakers

Guiliano Maino

Birte Melsen

Professor Melsen has held the title of Professor and Head of the Department of Orthodontics at The School of Dentistry, Aarhus University, Denmark since 1975. She has been working part-time in a private practice in Lübeck, Germany (Adult Orthodontics only) since 1986.

Professor Melsen has authored more than 350 publications in the fields of growth and development based on research of human autopsy material, bone biology and clinical implant studies. In recent years her professional interests have focused primarily on the fields of Skeletal Anchorage, Virtual Imaging and Adult Orthodontic Treatment.

In 2000 she received the Knighthood of Dannebrog 1st degree.

Camillo Morea



Dr. Camillo Morea is professor at the Specialty course in Orthodontics of the FUNDECTO – University of São Paulo, Brazil and Post-doctoral fellow at the Orthodontics Department of the University of São Paulo, Brazil. His primary interest is orthodontic mini-implants in all their

aspects including surgical technique, use of surgical guides and prototyped surgical guides. He has conducted research on histological aspects of mini-implants healing. Moreover, Dr. Morea has published several journal articles and book chapters.

Ravindra Nanda



Dr. Ravindra Nanda is at present UConn Alumni Endowed Chair, and Professor and Head of the Department of Craniofacial Sciences and Chair of division of Orthodontics, University of Connecticut, Farmington, Connecticut, U.S.A.

Dr. Nanda has done extensive research during the last forty years in the areas of cleft lip and palate, orthopedic forces and on long-term growth with orthognathic surgery in adolescents. In recent years, his major thrust has been in development of orthodontic wires, clinical orthodontic trials and application of biomechanics in a busy orthodontic practice. Dr. Nanda has been author and co-author of five orthodontic books and more than one hundred scientific and clinical articles in major journals. He is on the editorial board of ten different national and international orthodontic journals. He is an associate editor of Journal of Clinical Orthodontics.

He is an active member of various organizations, including the American Association of Orthodontists, European Orthodontic Society and Edward H. Angle Society. Dr. Nanda is a Diplomate of the American Board of Orthodontics. He has given numerous named lectures at national and international societies including Mershon Lecture at American Association of Orthodontics and Sheldon Friel Lecture at 2011 EOS Conference.

Junji Ohtani



Dr. Junji Ohtani is Assistant professor, Department of Orthodontics, at the Hiroshima University in Japan, since 2006. He is also a visiting professor of the Department of Craniofacial Anomalies at University of California, San Francisco (UCSF). He received

his dental education at Aichi gakuin University and completed PhD degree in Hiroshima University. Author of publications on national and international journals and books mainly devoted on orthodontics and the relationship with nutrition and bone.

Young-Chel Park



Dr. Young Chel Park is a professor of the department of orthodontics, at Yonsei university, College of Dentistry, in Seoul, Korea. He is a president of the World Implant Orthodontic Society and also he was a past president of the Korean Association of Orthodontists.

Dr. Park was a visiting professor at the University of Connecticut in the United States and the University of British Columbia in Canada. His primary focus is the implant orthodontics and the development of adult orthodontic treatment. Additionally Dr. Park has published multiple journal articles, book chapters and textbooks.

John R Smith

Sponsored by 

Dr. John R Smith earned his B.S. degree in Zoology from the University of Florida in 1971 and his D.D.S. degree in 1975 from Emory University. Graduating first in his dental class earned him the distinguished Alpha Omega Scholastic Award and membership into the Omicron Kappa Upsilon Scholastic Society. Perhaps the most notable achievement in Dr. Smith's career came after he received his Masters Degree in Orthodontics (M.S.D.) from the University of Washington. His graduate work in implantology gained him the coveted Milo Hellman International Research Award presented each year by the American Association of Orthodontists for the most outstanding orthodontic research. After graduation, Dr. Smith became interested in another area of orthodontics, "invisible braces". Working with five other noted orthodontists he helped pioneer the development of invisible braces. Through his publications and lectures, he has taught the theory of invisible braces and other innovations to thousands of orthodontists throughout the world. Dr. Smith holds membership in the American Association of Orthodontists (AAO), the American Lingual Orthodontic Association (ALOA), the Florida Society of Orthodontics, American Dental Association, Florida Dental Association, and the Orange County Dental Society.

Sponsorship & Exhibition

Junji Sugawara



Dr. Junji Sugawara is currently a Director at the SAS Orthodontic Centre, Ichiban-cho Dental Office, Sendai, Japan, and a Visiting Clinical Professor at the Division of Orthodontics, School of Dental Medicine, University of Connecticut, Farmington, He graduated from

Tohoku University, Sendai, Japan in 1973 and worked there over 30 years. He is an active member of the Edward H. Angle Society (North Atlantic Component) since 2004.

The Skeletal Anchorage System (SAS) utilizing the titanium miniplates as temporary anchorage devices and Sendai Surgery First are recent key interests and he has given many lectures on these subjects in the United States, Europe, South America, Australia, Middle East and Asia.

Teruko Takano-Yamamoto



Prof. Takano-Yamamoto is a professor and chair of the Department of Orthodontics, Tohoku University Graduate School of Dentistry. She graduated from Osaka University, and obtained her DDS, PhD at the Department of Orthodontics and Dentofacial Orthopedics,

Osaka University, Faculty of Dentistry. She is editorial board of Journal of Bone and Mineral Metabolism, and Orthodontics and Craniofacial Research, editorial review board of American Journal of Orthodontics and Dentofacial Orthopedics, and European Journal of Orthodontics, and review board member of Angle Orthodontics, Orthodontic Waves, and other journals. She is interested in the molecular and cellular mechanism of orthodontic tooth movement, mechanical response of osteocyte, bioengineered tooth, and basic and clinical aspects of orthodontic treatment using miniscrew anchorage. Publication of original papers is more than 300.

Flavio Uribe



Dr. Uribe received his Master's degree and Certificate in Orthodontics from the University of Connecticut after receiving his DDS degree from the Instituto de Ciencias de la Salud in Medellin, Colombia. He also completed a 3-year residency and fellowship program at the

Advanced Education in General Dentistry Program at the University of Connecticut.

Dr. Uribe is a full-time associate professor and program director in the Division of Orthodontics at the University of Connecticut Health Center. He is a diplomate of the American Board of Orthodontics and member of the Edward H Angle Society of Orthodontists. Dr Uribe is a section editor of the Book Temporary Anchorage Devices in Orthodontics and has authored and coauthored numerous book chapters and articles in peer reviewed journals.

Sponsorship Opportunities

The 4th World Implant Orthodontic Conference will create an influential environment for the exchange of information between industry professionals, leading researchers and decision makers. Aligning your company with this Conference will provide the potential to consolidate corporate relationships and expose staff to key markets.

Exhibition

The Exhibition will be a major component of the Conference and will feature the most up to date technology and equipment available. The Conference program has been designed to maximise attendance to the exhibition area. In addition to trade exhibits, refreshment breaks, lunch and internet facilities will all be held within the exhibition arena thus creating the networking hub of the Conference. Furthermore, the program auditoria and the exhibition area are located only a few minutes' walk from each other, facilitating a high level of delegate visitation to the exhibition.

Further Information

For further information about the Sponsorship and Exhibition business opportunities or a copy of the prospectus please contact:

Sponsorship and Exhibition Manager
WIOC2012 Conference Secretariat
GPO Box 3270
Sydney NSW 2001

Telephone: +61 (0) 2 9254 5000

Facsimile: +61 (0) 2 9251 3552

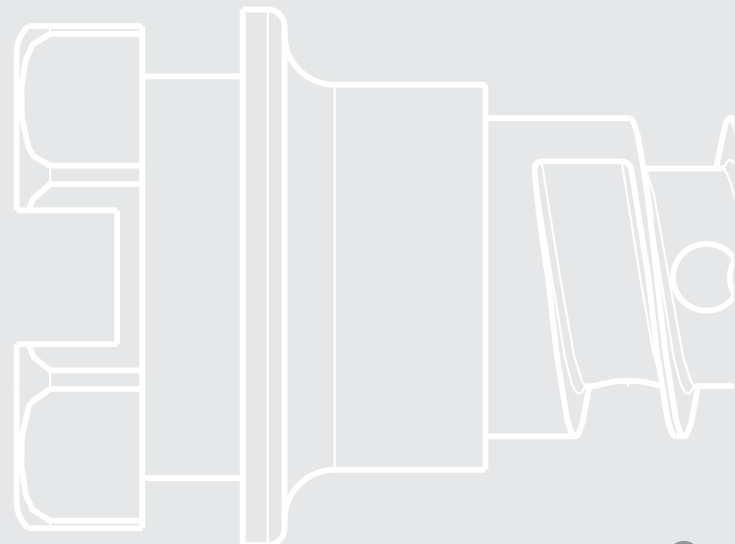

Email: sponsorship@wioc2012.com



Program at a Glance

Wednesday 10 October 2012: Industry Sponsored Workshops

To facilitate hands-on learning, the following workshops will be offered:

0800 – 1700	Speaker: John R Smith <i>Sponsored by</i>  Speaker: Sebastian Baumgaertel <i>Sponsored by</i> 
1900 – 2100	President's Welcome Reception, Level 3 Exhibition Area, Hilton Sydney

Thursday 11 October 2012

0700 – 0830	Coffee and Registration
0830 – 1010	Introduction and Welcome Tiziano Baccetti Memorial Lecture Postgraduate Presentations
1010 – 1030	Morning Tea and Posters
1030 – 1210	Plenary Lectures and Postgraduate Research Presentations
1210 – 1400	Lunch
1400 – 1640	Concurrent Sessions
1640 – 1730	Afternoon tea and Poster Session
Evening	Conference Party, The Ivy

Friday 12 October 2012: Auxiliary Staff Program

0800 – 1000	Presentations
1000 – 1030	Morning Tea
1030 – 1230	Concurrent Sessions
1230 – 1330	Lunch
1330 – 1530	Presentations and Photography Course
1530 – 1600	Afternoon Tea
1600 – 1700	Presentations and Photography Course

Friday 12 October 2012:

Australian Society of Orthodontists Clinical Day

0800 – 0815	Welcome by Dean of Dentistry
0815 – 1000	Presentations
1000 – 1030	Morning Tea
1030 – 1215	Presentations
1215 – 1330	Lunch
1330 – 1500	Presentations
1500 – 1530	Afternoon Tea
1530 – 1700	Presentations
Evening	ASO Dinner

Saturday 13 October 2012

0700 – 0830	Coffee and Registration
0830 – 1010	Concurrent Sessions
1010 – 1030	Morning Tea and Posters
1030 – 1210	Concurrent Sessions
1210 – 1400	Lunch
1400 – 1630	Concurrent Sessions
1630 – 1640	Award Presentations, Closing Remarks and Introduction to 5th WIOC
Evening	Postgraduate Disco

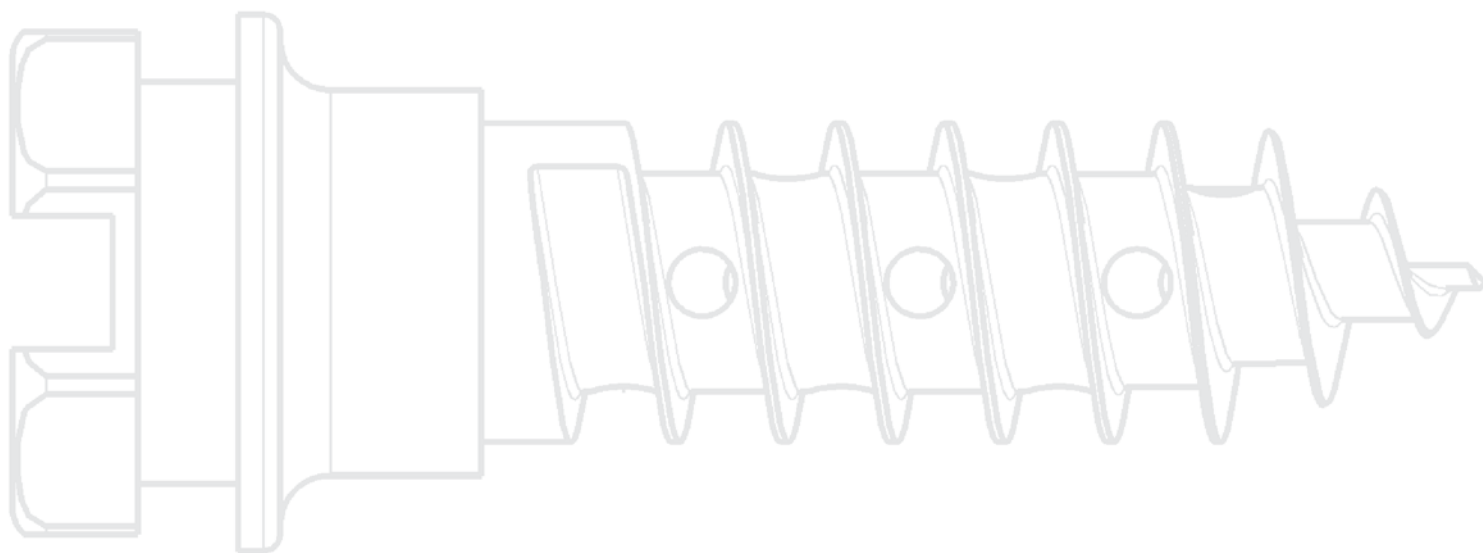

Call for Abstracts

Call for Abstracts – NOW OPEN

The Committee invites abstracts of original submissions for oral and poster presentations. Submission of abstracts is via the Conference website www.wioc2012.com

All abstracts must be submitted in English and online. Other forms of submission e.g. by post, email or fax, will NOT be accepted.

Authors of accepted oral and poster presentations will be notified by email in June 2012. Note that all presenters must register by 31 July 2012.

Instructions for submission of abstracts via the Conference website are included below. If you are unable to submit an abstract via the web, please contact the Conference Secretariat to make alternative arrangements.

Poster Session

Each poster selected for presentation at the 4th World Implant Orthodontic Conference will be displayed at the Conference. Presenters will be available at scheduled times to answer any questions and discuss their results. Poster sessions will provide an opportunity for delegates to mingle with new and old colleagues, stimulate their scientific appetite and have a professional interface with industry sponsors.

Young Chel Park Award for best young researcher

The Committee also invites young researchers (up to five years post graduation) to submit abstracts to be considered for the Young Chel Park Award. Six finalists will be chosen to present at the conference with one winner being announced on Saturday afternoon in the last session. The winner will receive free registration for the 5th World Implant Orthodontic Conference. Submission of abstracts is via the Conference website www.wioc2012.com

The deadline for receipt of abstracts is **12 May 2012**. Authors will be notified of the results of the review process in June.

The Early Bird Registration deadline is 31 July 2012.

Abstract Submission

General Information

- Original abstract must be submitted by 12 May 2012
- Obtain consent from co-authors prior to submission
- Only abstracts submitted in English will be reviewed
- Restrict the word count to a maximum of 300
- Abstracts cannot contain scientific symbols, diagrams, photographs and/or tables
- Abstract Title (Time New Roman size 12 font, bold, left aligned, initial capitals)
- Authors (Time New Roman size 12 font, Surname, Initials Presenting Author to be bold)
- Affiliations (Time New Roman size 12 font, Affiliation, City, Country)

- Abstract text (Time New Roman size 12 font, left aligned, maximum 300 words, single line spacing). DO NOT include tables or pictures. Abstracts may not be reviewed if word count exceeds 300

Instructions for Authors

The abstract must contain:

- An introductory sentence indicating the purpose of the study titled **Aim**
- A brief description of methods titled **Methods**
- A summary of new data arising from this study titled **Results**
- A conclusion and context statement titled **Conclusion**
- References critical to the abstract. Use limited reference detail (e.g. Smith, JA 1999)
- Disclosure of conflict of interest

The abstract will appear in print as submitted

Successful Authors will be notified in **June 2012**

All presenters of accepted abstracts will be expected to pay the Conference registration fee. Abstracts will not be accepted for inclusion into the program or abstract booklet until the registration fee is paid.

The deadline for **early bird registration is 31 July 2012.**

Publication of Abstracts

All abstracts accepted for presentation will be published in the Conference abstract book once the registration fee has been paid.

The abstract will appear in print as submitted. For this reason adherence to guidelines is essential.

Poster authors will be asked to stand by their poster during the scheduled poster presentation times. Authors will be notified of these times via the Conference Notice Board.

Full and additional details will be included in the acceptance letter, which will be emailed and mailed to the first author in June 2012.

Disclosure/Conflict of Interest

Authors will be required to disclose any conflict of interest including affiliations with sponsoring companies within the body of their abstract. Disclosures will be included in the Conference program book. The presenting author is responsible for this information.

Confirmation of Receipt of Abstract

You will be sent an acknowledgement via email to confirm that your abstract has been received. If you do not receive the acknowledgement within three (3) working days of your submission, please contact the Conference Secretariat on program@wioc2012.com or telephone +61 (0) 2 9254 5000.

Registration

Please read this page carefully before completing the registration form.

How to Register

Register now online at www.wioc2012.com/registration

To attend the Conference, fill in the registration form and return to the Conference secretariat. Each delegate must complete a separate form. Photocopy for additional copies or contact the secretariat. Please read this booklet carefully before completing the registration form.

Forms will be accepted by post, fax or online through the Conference website:

WIOC2012 Conference Secretariat
GPO Box 3270
Sydney NSW 2001
Australia
Tel: +61(0) 2 9254 5000
Fax: +61 (0) 2 9251 3552

Email: info@wioc2012.com
Website: www.wioc2012.com

Early bird registration closes on 31 July 2012.

Registration Fees

All fees are quoted in Australian dollars (AUD) and are inclusive of 10% GST. Registrations made after 8 October must be made onsite at the Conference Registration Desk at the Sydney Convention and Exhibition Centre.

	Early Bird Rate Before 31 July 2012	Standard Rate 31 July – 10 October 2012
Full Delegate	\$1100	\$1250
Full Delegate including ASO Clinical Day	\$1250	\$1400
Postgraduate/Student**	\$550	\$700
Postgraduate/Student including ASO Clinical Day**	\$700	\$850
Day Delegate	\$660	\$660
Day Postgraduate/Student Delegate**	\$450	\$450
Auxiliary Staff Program	\$550	\$550
ASO Clinical Day	\$950	\$950
Developing Countries Delegate*	\$550	\$550
Hands-on Pre-conference Workshop – Dr Smith – sponsored by Ormco***	\$295	\$295
Accompanying Person	\$195	\$195

*Developed economies include Australia, Bahrain, Canada, EU and other middle Eastern and Northern European nations, Israel, Japan, New Zealand, Saudi Arabia, Singapore, Taiwan, South Korea, Kuwait, Qatar, United Emirates and USA.
Developing economies include all others.

**Please note that all delegates registering as a student will be required to send a copy of their Student ID proving they are a full time student to registration@wioc2012.com within one week of registering to attend the Conference. If this information is not received then the registration rate will be increased to the applicable registration fee payable at the time.

***For the Dentaurum Sponsored Workshop featuring Dr Baumgaertel please refer to the Dentaurum flyer on the website.

Registration Entitlements

Full Delegate, Postgraduate/Student and Developing Country delegate registration includes:

- Attendance at all scientific sessions and exhibition
- Name badge and pocket program
- Satchel including program, program book and list of delegates
- Morning Tea (Thursday and Saturday)
- Lunch (Thursday and Saturday)
- Afternoon Tea (Thursday and Saturday)
- Certificate of Attendance
- Attendance at Welcome Reception (Wednesday)
- Attendance at Conference Party (Thursday)

Day delegate registration includes the above for one day only.

Attendees to the Auxiliary Staff Program also include all day catering during the day on Friday and attendance at the sessions.

Accompanying Person Registration includes:

- Welcome Reception (Wednesday)
- Conference Party (Thursday)

Australian Society of Orthodontists Clinical Day includes:

- Attendance at the ASO day on Friday 12 October
- Name badge and pocket program
- Satchel including program, program book and list of delegates
- Morning Tea (Friday)
- Lunch (Friday)
- Afternoon Tea (Friday)
- Certificate of Attendance

ASO Clinical Day and Full Delegate includes:

- Attendance at all scientific sessions and exhibition
- Attendance at the ASO day on Friday 12 October
- Name badge and pocket program
- Satchel including program, program book and list of delegates
- Morning Tea (Thursday – Saturday)
- Lunch (Thursday – Saturday)
- Afternoon Tea (Thursday to Saturday)
- Certificate of Attendance
- Attendance at Welcome Reception (Wednesday)
- Attendance at Conference Party (Thursday)

Method of Payment

Payment of fees must accompany all registration forms. No registration will be confirmed until payment is received.

Payment can be made by the following methods:

- **Credit cards:** Visa, MasterCard, American Express and Diners Club
- **Personal or Company Cheque** (Australian Delegates Only) and made payable to: *4th World Implant Orthodontic Conference*
- **Bank drafts and International Money Orders** should be in Australian Dollars, drawn on an Australian Bank and made payable to *4th World Implant Orthodontic Conference*. Please fax a copy of the bank remittance to +61 (0) 2 9251 3552.

Payment Deadlines

Registrations received on or before 31 July 2012 must be paid in full by 31 July 2012 in order to receive the early bird registration rate. Registrations received between 1 August 2012 and 10 October 2012 must be paid in full by 10 October 2012 in order to receive full registration entitlements. Failure to adhere

to the deadlines will result in your registration being automatically cancelled, and the need to re-register for the Conference.

Cancellation of Registration

Deadline: 10 September 2012

Cancellations must be made in writing to the Conference Secretariat. Cancellations received prior to 10 September 2011 will receive a full refund less a AUD \$150 administration fee. Cancellations received after 10 September 2011 will not be refunded. The committee will consider cancellations of registration under exceptional circumstances. Refunds will not be granted on failure of visa application. Substitute delegates will be accepted in writing.

Disclaimer

All best endeavours will be made to present the program as printed in this document. The meeting and its agents reserve the right to alter without prior notice, any of the arrangements, timetables, plans or other items relating to the meeting, for any cause beyond its reasonable control. The Organising Committee and the Meeting Organisers are not liable for any loss or inconvenience caused as a result of such alteration. In the event of unforeseen circumstances, the 4th World Implant Orthodontic Conference, Organising Committee and the Meeting Organisers do not accept responsibility for loss of monies caused by delays.

Participants are advised to take out personal travel insurance and to extend their policy to cover personal possessions. The meeting does not cover individuals against cancellations of bookings or theft or damage to belongings.

Enquiries

Please direct all registration and accommodation queries to:

4th World Implant Orthodontic Conference
GPO Box 3270
Sydney NSW 2001
AUSTRALIA
Telephone: +61 (0) 2 9254 5000
Facsimile: +61 (0) 2 9251 3552
Email: info@wioc2012.com
Website: www.wioc2012.com

Street Address (for couriers only)
WIOC2012 Conference Secretariat
ICMS Australasia Pty Ltd
Level 9, 234 George Street
Sydney NSW 2000
AUSTRALIA

Social Program

Host City & Venue

The Conference Social Program will be a time for delegates to catch up with old friends and meet new ones in a relaxed atmosphere, away from the hustle and bustle of the scientific sessions.

Magnificent venues, fine wines, delicious food and a relaxed atmosphere will ensure great memories are taken home.

President's Welcome Reception

Date: Wednesday 10 October 2012

Time: 1900 – 2100

Venue: Hilton

Tickets: Included for all registered delegates

Meet with old and new colleagues in a relaxed and informal environment whilst enjoying drinks and canapés. Admission to the reception is included for all fully registered delegates and students. Additional tickets can be purchased. Tickets will be distributed from the registration desk.



Conference Party

Date: Thursday 11 October 2012

Time: 1930 – 2300

Venue: The Ivy

Dress: smart casual

Tickets: Included for all registered delegates

Australia is world-renown for its superb fresh food and award-winning wine. Join fellow delegates for an evening of outstanding entertainment at one of Sydney's most stylish and contemporary venues in the heart of the city. Not to be missed.

Sydney – Host City

Sydney, Australia is the host city for the 4th World Implant Orthodontic Conference to be held from 11 to 13 October 2012.

Sydney is without doubt one of the most beautiful cities in the world with a reputation for friendly people, a cosmopolitan lifestyle, wonderful shopping and world-class entertainment. Our magnificent harbour, renowned Opera House and sunny beaches combine to make Sydney a unique destination and a city of sophistication and fascinating variety.

The Venue – The Hilton, Sydney

Offering a contemporary design, coupled with state-of-the-art facilities and a distinctive flair for culinary creativity, the Hilton Sydney is the ideal location for the WIOC2012. Located in the heart of the city with magnificent view, it provides comfort, convenience and style with close access to Sydney's central business and shopping district, offering a truly inspired experience.

Parking

Parking is available at the Hilton, Sydney. The entrance is via 259 Pitt Street.

The car park is available 24/7



General Information

General Information and Information for Visitors to Australia

Currency

Decimal currency is used in Australia – units are dollars and cents. Current exchange rates can be obtained from your bank. All major credit cards are widely accepted in Australia.

Visit www.xe.com for current exchange rates.

Banks

Normal banking hours are Monday to Thursday 9.30am-4.00pm and Fridays 9.30-5.00pm, excluding public holidays. 24 Hour Automatic Teller Machines (ATMs) can be found throughout the City and Shopping Centres.

There are four major banks in Australia which offer a full range of banking services including currency conversions and sales of travelers cheques including Commonwealth Bank, Westpac Bank, ANZ Bank and the National Bank.

Time

Local Sydney time during September is – Greenwich Mean Time plus 11 hours.

Climate

In Sydney, October is a month of our Spring season and you can look forward to temperatures of approximately 11-19°C (52-66°F).

Shopping

Shops open from 9.00am to 5.30pm during the week with late night shopping on Thursdays to 9.00pm. On Saturdays and Sunday most shops are open between 9.00am and 4.00pm.

Travel and health insurance

The meeting does not provide insurance to delegates. We strongly recommend that you take out insurance policies to cover medical and travel expenses. If necessary, consult your travel agent.

Wheelchair access or other mobility disability access during the meeting

When you register, please notify the meeting secretariat of any mobility disabilities you have so that any venue access challenges can be addressed.

Transport from the airport

All delegates must make their own transport arrangements from the airport. The following are estimates only of travel from the airport to the central business district.

- Taxi: \$20 to \$30
- Train Link to Central Station: \$8 to \$15
- Airport Shuttle: \$10 to \$15



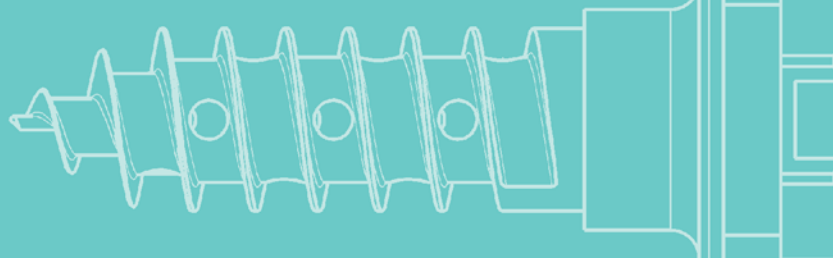

Public transport around Sydney

Sydney's public transport network allows easy travel around the city. Considerable savings on buses and harbour ferries can be obtained with the State Transit Travel pass. Taxis can either be booked by telephone or hailed from the street.

There are frequent monorail and light rail services linking Darling Harbour with the city and a regular ferry service (15 minutes each trip) between Darling Harbour and Circular Quay (downtown).

Taxes

A Goods and Services Tax (GST) of 10% applies to all consumer goods and is included in retail prices. All fees are quoted in Australian Dollars and are subject to GST.

Tipping

Tipping is not the general custom in Australia and service charges are not added to accounts by hotels and restaurants. However, you may tip hotel porters and food and drink waiters in restaurants (up to 10% of the bill) for special service. At any time, tipping is at your discretion.

Eating Out

Restaurants and cafes offer varied menus, prices and décor. Local seafood delicacies are recommended and include Oysters, King Prawns, Queensland Mud Crab, Balmain Bugs and Barramundi. These are delicious when accompanied by Australian wines, many of which have won major international awards.

Mobile Phones

Australia operates on a digital network.

Things you cannot bring into Australia

Australia has very strict importation laws and like most countries we place great emphasis on protecting our native fauna and flora from infectious diseases and other hazardous substances. The Australian Quarantine and Inspection Service (AQIS) provides quarantine inspection services for the arrival of international passengers, cargo, mail, animals and plants or their products into Australia, and inspection and certification for a range of animal and plant products exported from Australia. For more information regarding specifically what you are able to bring into Australia visit the Australian Quarantine and Inspection Service website at www.aqis.gov.au

No-Shows

Delegates who confirm attendance and provide credit card details but do not advise of cancellation before the 30 day period of Conference commencement will incur charges for the



'no-show' rate, as penalised by the hotel. This charge is calculated as the room rate per night multiplied by the dates booked and secured. Please ensure that accommodation dates are correct at time of booking.

Visas

Australia has strict immigration laws, however generally all visitors (other than those traveling on a New Zealand passport) will require a visa to enter the country.

Overseas visitors seeking to attend, or participate in the Conference should, in most cases, apply for a short stay business visitor visa (subclass 456).

It is recommended that before registering, you check immigration details with your airline, travel agent or nearest Australian embassy or consulate (see www.dfat.gov.au/missions for full list). Immigration information can also be found on the Australian Government website www.immi.gov.au/visitors/iecn.htm

Some visitors will be able to obtain an Electronic Travel Authority (ETA). You may apply for an ETA online via www.eta.immi.gov.au or through a travel agent, an airline office or a specialist service provider.

After registering and paying to attend the Conference, a 'Letter of Confirmation' will be sent which you may use with your visa application.

NOTE. A 'Letter of Invitation' is generally not required to obtain a visa to attend the Conference, however should your particular circumstances require such a letter, please contact the Sydney Secretariat via email (info@wloc2012.com.au) promptly to arrange the relevant documentation.

IMPORTANT. Please apply for a visa to Australia at least two months before your proposed departure

Accommodation

A wide range of accommodation has been reserved for delegates and their guests at highly competitive rates. Rates quoted are per room per night and inclusive of 10% GST. *Accommodation bookings are subject to availability.*

Hilton Hotel

488 George Street, Sydney (5 star)

Single/DBL/TWN: \$349 room only

Metro Hotel on Pitt

300 Pitt Street, Sydney (4 star)

Walking distance – 3-4 minutes

Standard Single/DBL/TWN: \$155.00 room only

\$173.00 including breakfast for one person

\$191.00 including breakfast for two people

Superior Single/DBL/TWN: \$165.00 room only

\$183.00 including breakfast for one person

\$201.00 including breakfast for two people

Superior Deluxe DBL/TWN: \$175.00 room only

\$193.00 including breakfast for one person

\$211.0 including breakfast for two people

Metro Hotel Sydney Central

431-439 Pitt Street, Sydney (3.5 star)

Walking distance – 8 minutes

Superior Single/DBL/TWN: \$155.00 room only

\$173.00 including breakfast for one person

\$191.00 including breakfast for two people

BOOKING DEADLINE: 03 September 2012

You are encouraged to book your accommodation through the Conference Secretariat to ensure that you receive very competitive rates. Transfers to the Conference social functions will only be available to those delegates who book accommodation at the below Conference hotels.

Deposits

Accommodation will not be confirmed until a deposit of one night's tariff is received. This deposit will be forwarded to your hotel and will be credited to your room account. Delegates must settle the balance of their account with the hotel concerned upon check out. If accommodation deposits are not received before 3 September 2012 your room will be released back to the hotel. The Conference secretariat does not take responsibility for accommodation if deposits are not received by this date.

Deadline for accommodation bookings

The Secretariat has an obligation to return all unsold rooms to the hotels/apartments on 3 September 2012, therefore accommodation bookings and rates reserved after that date cannot be guaranteed. The rates quoted are only valid for bookings made prior to **3 September 2012**.

Late bookings can be made through the Conference secretariat after **3 September 2012**, but are subject to availability and credit card details are required to secure the reservation. One night's accommodation tariff will be deducted from the supplied credit card, by the hotel, if the reservation is cancelled or the delegate fails to arrive on the specified date.

Cancellations

No accommodation deposits will be refunded on or after 3 September 2012.

Delegates who confirm attendance and provide credit card details but do not advise of cancellation before the 30 day period of Conference commencement will incur charges for the 'no-show' rate, as penalised by the hotel. This charge is calculated as the room rate per night multiplied by the dates booked and secured. Please ensure that accommodation dates are correct at time of booking.

Early arrival

Some international flights arrive in Sydney in the very early morning. As check in is not until 3.00pm at most hotels, it is possible that your room may not be ready for immediate occupation on your early arrival. Whilst hotels will do everything possible to accommodate early arrivals, if you wish to be guaranteed immediate occupation you can pay an extra day's tariff for the night before you are due to arrive. If you wish to take this precaution, please advise the Secretariat on the registration form so that we can notify the hotel that your room is pre-registered.

Late arrival

Please indicate if you will arrive at your hotel after 6.00pm. Failure to do so might result in your room being released.

Change of booking

Any change in booking must be made in writing to the Conference Secretariat and NOT directly to the hotel.

Group accommodation bookings

The Conference Secretariat offers organisations the opportunity to contract ten or more rooms for the Conference. This requires a contract to be signed by ICMS Australasia and your organisation to block the group reservation.

Further Information

For further information, please email the Conference secretariat with the following information:

- Choice of Hotel
- Number of rooms required
- Check in and out dates
- Organisation
- Contact name

Day Tours

Blue Mountains

Explore the world heritage listed Blue Mountains stretching over one million hectares. It is an inspiring mix of rainforest, canyons and tall forests, truly one of Australia's natural wonders. View this wonderland of sandstone outcrops, deep ravines, pristine bushland and dramatic cliffs. This rugged and beautiful region forms part of the Great Dividing Range- linking tropical north to temperate south, while dividing coastal cities from the vast outback. Stop at Echo Point and see the famous Three Sisters rock formation and discover the Aboriginal dreamtime legends. Follow the scenic cliff drive and enjoy breathtaking views of the Megalong Valley. Travel through Katoomba – heart of the resort region within the Blue Mountains and enjoy an easy walk and stroll along the boardwalk through the rainforest. Time for a light lunch...

Ride the steepest incline railway in the world down to the lush and hidden valley. Glide out of the valley on the cableway taking in panoramic views and take a ride on the recently unveiled Skyway, a journey 370 metre above ancient ravines and dazzling waterfalls. Take in the fabulous views from Govett's Leap Lookout then enjoy a guided bushwalk along the Fairfax Heritage Walk. Return to Sydney after having an unforgettable day.

Hunter Valley Wineries.

Explore the fertile Hunter Valley and taste award winning regional food and wines. Enjoy private vineyard inspections and learn of the winemaking process. Spend your time strolling amongst the vineyards, purchase some wines or just enjoy the beautiful Australian countryside. Be treated to magnificent views of the Hawkesbury River in the morning. See the remains of a convict built road winding into the Hunter Valley and stroll around the historic Wollombi Village.

Home to Australia's oldest wine producing region, the Hunter Valley owes its fame to world class viticulturalists and fertile soils. Enjoy a private wine tasting experience at world renowned Lineman's. A delicious gourmet luncheon is accompanied by wine tastings. Return back to Sydney to relax after an amazing day in Australia's countryside.



Taronga Zoo

You will be met by your guides at The Taronga Centre and enjoy a special one-on-one encounter with a native animal.

Enjoy a cooked breakfast in the Zoo grounds overlooking spectacular Sydney Harbour. Enjoy exclusive use of the Zoo grounds prior to opening with a fully escorted early morning tour of the Australian animal exhibits with expert guides, visiting the kangaroos, koalas, wombats, echidnas and Australian birds.

Also experience our "Platypus Pools", which recreate the wonder of a Blue Mountains sandstone gorge where you can see over 40 species of Australian animals and the recently discovered "dinosaur tree", the Wollemi Pine. As well as all day access to the Sky Safari Cable Car.



Sydney Harbour BridgeClimb

The express climb is a new climbing adventure and is the fastest way to the top of Sydney Harbour Bridge. On this climb, your time is a priority, so there are more team members to assist with a quicker climb preparation, allowing you to discover the wonders of the Bridge in just 2 hours and 15 minutes. In a smaller group of up to 12 climbers, you will wind above the harbour on catwalks, scale the steel heart of this structural masterpiece and emerge to a unique summit experience via a mammoth staircase between the two arches of the Bridge.

Along the way, one of the Bridgeclimb's professional Climb Leaders will share the Bridge's rich history, leaving you in awe of this incredible feat of engineering. The summit is 134 metres above the water, where you will be rewarded with amazing panoramic views of this beautiful Harbour city.

A professional climber leader will take pictures of you on the climb and at the end you will receive a commemorative Climb certificate and a complimentary group photograph.

2012

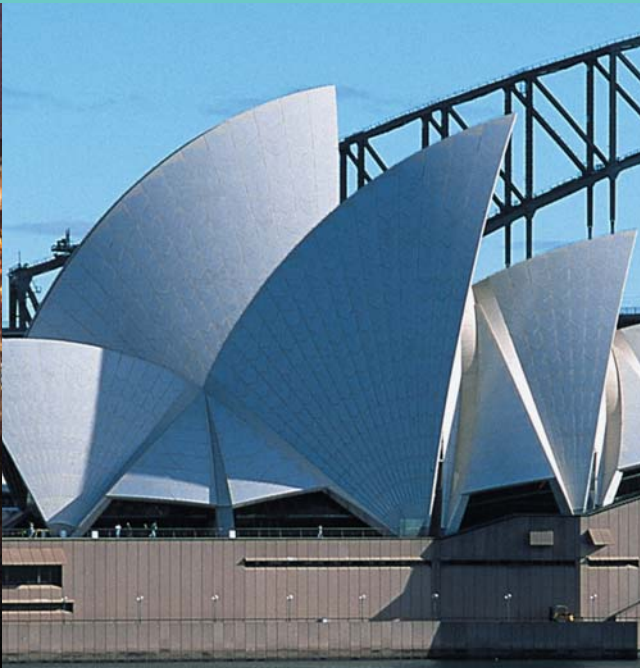

Contact us

Conference Organisers
ICMS Australasia Pty Ltd
GPO Box 3270
Sydney NSW 2001

Telephone: +61 (0) 2 9254 5000
Fax: +61 (0) 2 9251 3552
Email: info@wioc2012.com

W



4th World Implant Orthodontic Conference

www.wioc2012.com ABN: 47 067 147 411